

1

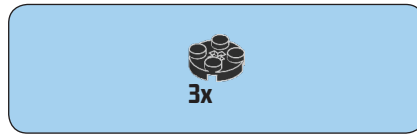

2

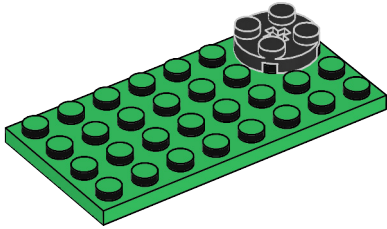

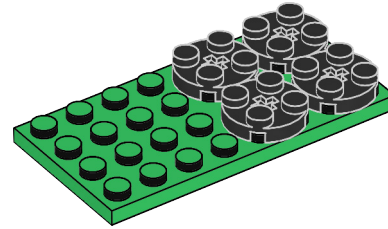

4x

3

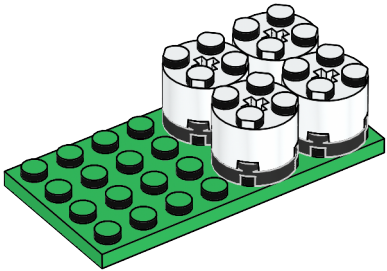

2x



1x

4

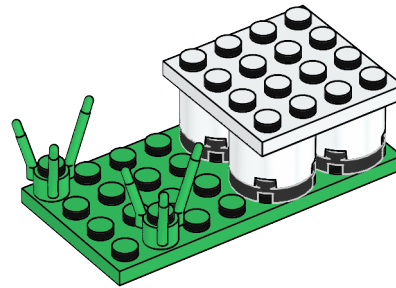



5x

5

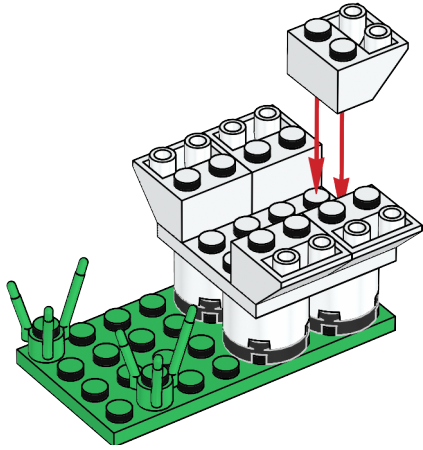

1x

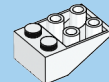

1x

6

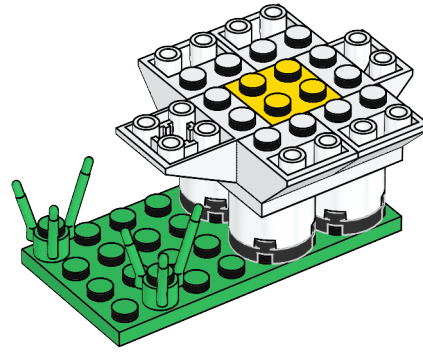

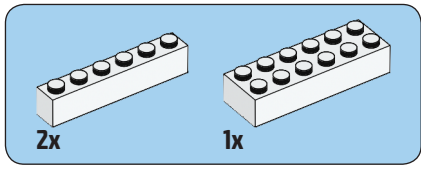

7

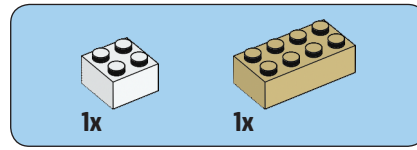
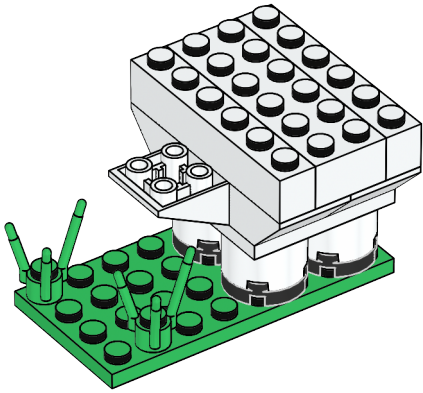

8

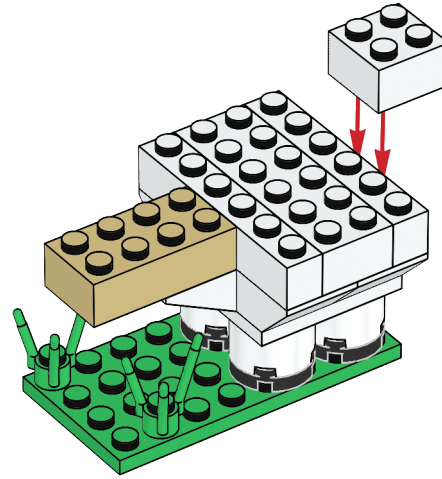

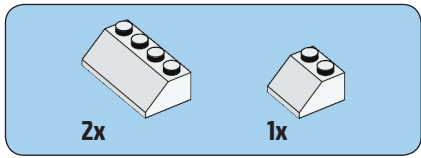

9

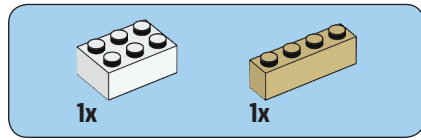
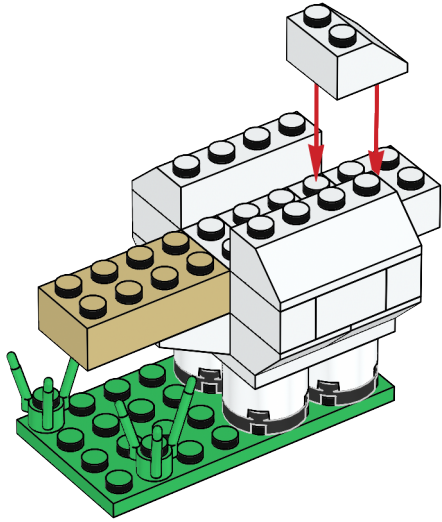

10

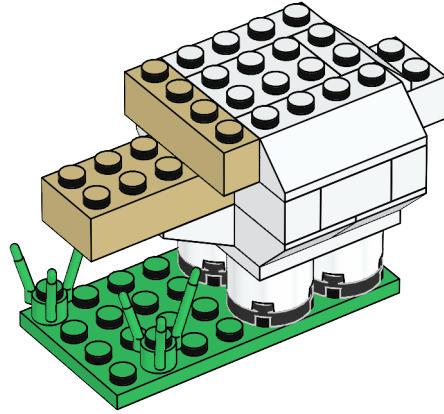



1x



2x

11

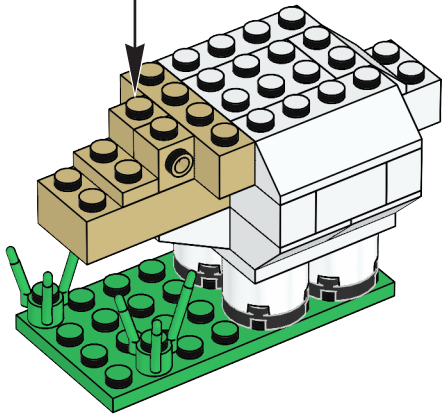
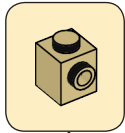

1x



2x

12

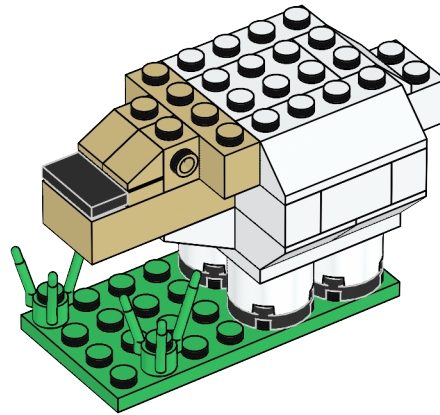

2x

13

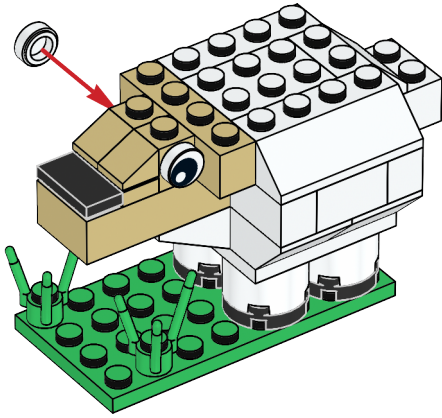

1x

14

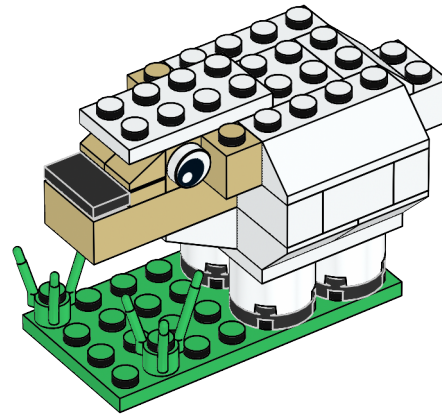





**1x**  
300301



**1x**  
300201

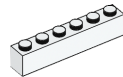

**2x**  
300901

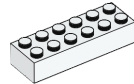

**1x**  
4181142



**4x**  
614301



**5x**  
366001



**1x**  
303901



**1x**  
4500469



**2x**  
303701



**1x**  
302001



**1x**  
4243812



**2x**  
6029156



**1x**  
4113916



**1x**  
4114319



**2x**  
4579260



**2x**  
4516055



**1x**  
4113917



**1x**  
300324



**1x**  
306926



**4x**  
403226

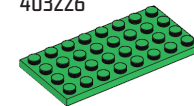

**1x**  
4277361



**2x**  
374128

