

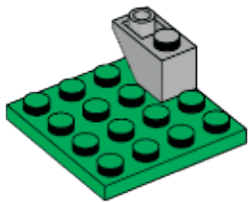

1

1x 1x



2

1x 2x

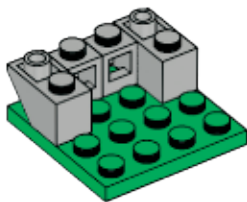

3

2x 2x

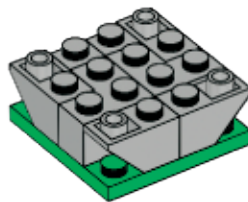

4

1x 1x

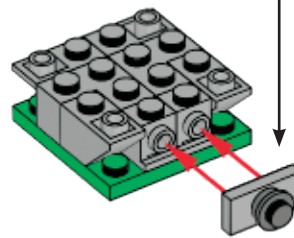
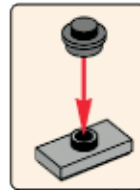

5

2x

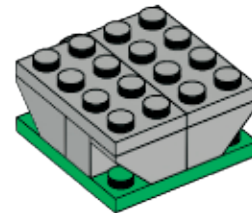

6

1x 2x 1x

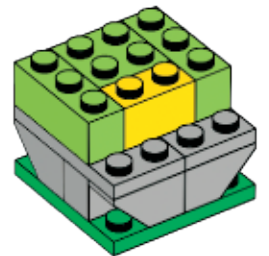

7

2x 4x

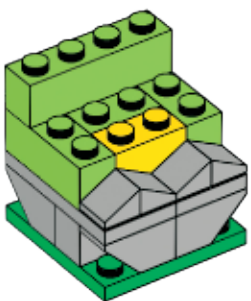

8

1x 2x 2x

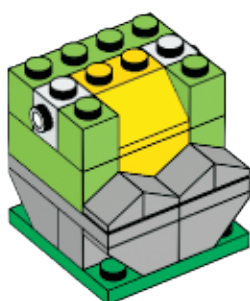

9

1x 2x 2x

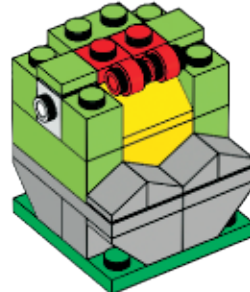

10

1x 2x

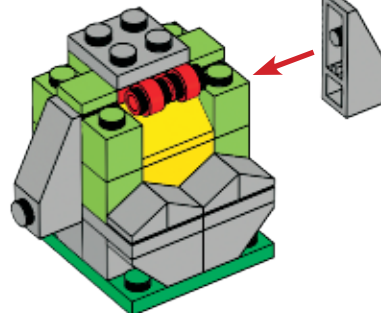

11

2x 2x

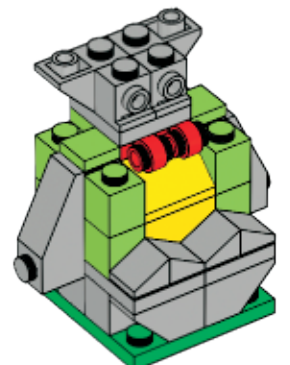

12

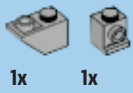

1x 1x

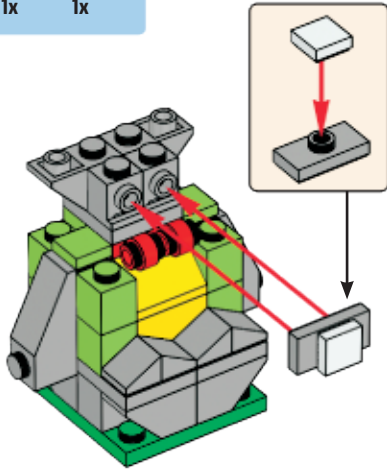

13

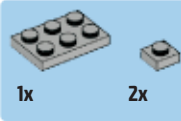

1x 2x

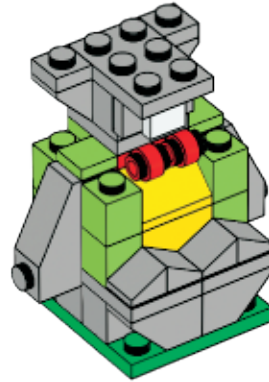

14

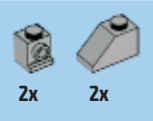

2x 2x

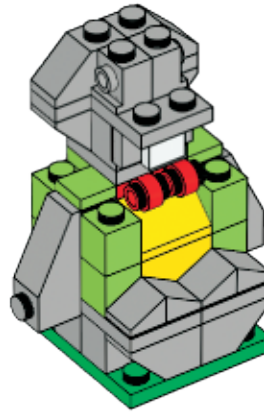

15

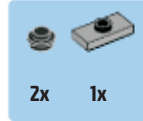

2x 1x

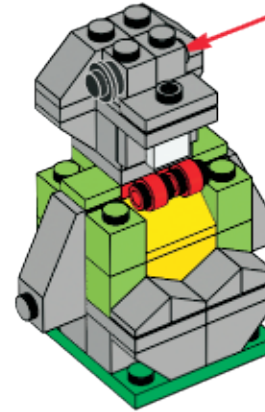

16

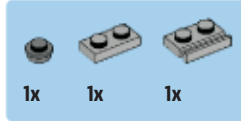

1x 1x 1x

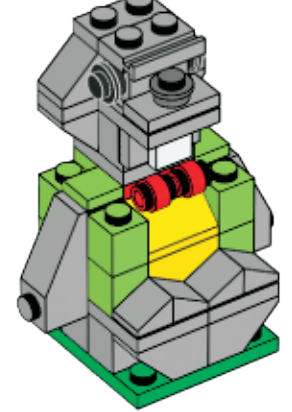

17

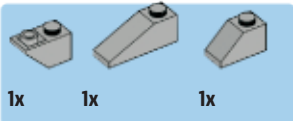

1x 1x 1x

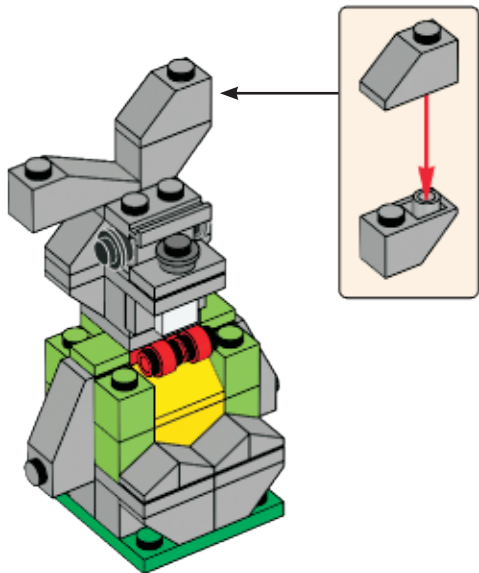

2x 4558952	1x 303924	1x 4220632	2x 4211349	3x 4211488	1x 4211396
1x 307001	2x 614126	2x 4166093	6x 4211476	2x 4211399	2x 4211395
2x 4632572	1x 4243821	1x 4234716	4x 4521921	1x 4211398	1x 4211568
					2x 4210633
1x 300424	2x 4220634	1x 4164037	7x 4211437	3x 4211451	
		2x 4537251	3x 4211614	1x 4211397	